

SPILLSTENSILER

singelen 2, 16. august 2010

Mappen: **1(1)**
Runden: **1**

Nord / Ingen

A
QJ95
AT93
J853

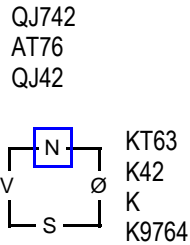

985
83
8765
AQT2

Bord	NS	ØV	NS	ØV	NS	ØV
2	11 10	13 5 4 NT	Ø 6	200	4,0	-4,0
1	2 6	3 8 5 Kløver D	Ø 10	100	2,0	-2,0
3	4 7	12 14 3 NT	V 9	400	-10,0	10,0
4	1 9	15 16 WO				

Mappen: **2(2)**
Runden: **1**

Øst / N/S

QJT6
63
AQJ97
94

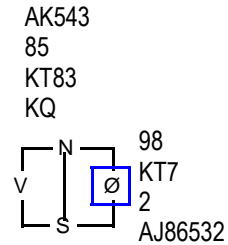

72
AQJ942
654
T7

Bord	NS	ØV	NS	ØV	NS	ØV
2	11 10	13 5 4 Hjerter	S 10	620	12,0	-12,0
4	1 9	15 16 WO			2,0	-2,0
1	2 6	3 8 3 Spar	N 8	100	-2,0	2,0
3	4 7	12 14 3 Spar	N 6	300	-6,0	6,0

Mappen: **3(3)**
Runden: **2**

Syd / Ø/V

J8
62
A632
QJ953

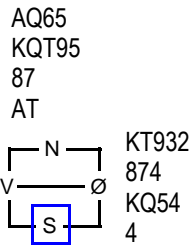

74
AJ3
JT9
K8762

Bord	NS	ØV	NS	ØV	NS	ØV
1	3 7	4 9 3 Spar D	Ø 7	500	10,0	-10,0
2	12 11	14 6 3 Hjerter	N 9	140	2,0	-2,0
3	5 8	13 1 4 Hjerter D	N 9	100	-5,0	5,0
4	2 10	15 16 WO				

Mappen: **4(4)**
Runden: **2**

Vest / Alle

A53
Q83
T964
T98

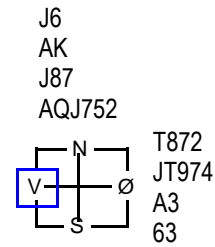

KQ94
652
KQ52
K4

Bord	NS	ØV	NS	ØV	NS	ØV
2	12 11	14 6 3 NT	N 12	690	1,0	-1,0
3	5 8	13 1 3 NT	S 11	660	0,0	0,0
1	3 7	4 9 3 NT	N 11	660	0,0	0,0
4	2 10	15 16 WO			-12,0	12,0

Mappen: **5(5)**
Runden: **3**

Nord / N/S

K8
86
AQ8763
KQ6

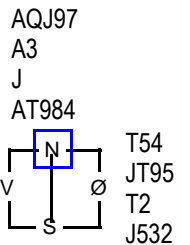

632
KQ742
K954
7

Bord	NS	ØV	NS	ØV	NS	ØV
2	13 12	1 7 4 Spar	N 12	680	9,0	-9,0
3	6 9	14 2 4 Spar	N 10	620	7,0	-7,0
1	4 8	5 10 6 Spar	N 10	200	-11,0	11,0
4	3 11	15 16 WO				

Mappen: **6(6)**
Runden: **3**

Øst / Ø/V

965
AJT7
93
Q874

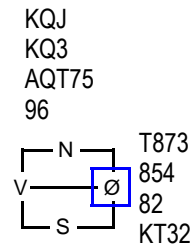

A42
962
KJ64
AJ5

Bord	NS	ØV	NS	ØV	NS	ØV
2	13 12	1 7 6 Ruter	S 12	920	10,0	-10,0
3	6 9	14 2 3 NT	S 12	490	1,0	-1,0
1	4 8	5 10 3 NT	N 11	460	-1,0	1,0
4	3 11	15 16 WO			-10,0	10,0

SPILLSTENSILER

singelen 2, 16. august 2010

Mappen: 7(7)
Runden: 4

Syd / Alle

A86
T9632
63
J76

T9
754
KQ2
AKQ82

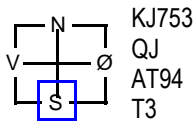

Q42
AK8
J875
954

Bord	NS	ØV	NS	ØV	NS	ØV
2	14 13	2 8 3 Kløver	N 10	130	1,0	-1,0
4	4 12 15 16	WO			0,0	0,0
3	7 10	1 3 3 Kløver	N 9	110	0,0	0,0
1	5 9	6 11 3 Kløver	N 9	110	0,0	0,0

Mappen: 8(8)
Runden: 4

Vest / Ingen

KT62
A
AQJ952
87

AQJ4
KQT96
T
T53

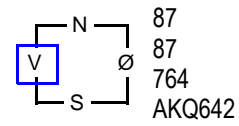

953
J5432
K83
J9

Bord	NS	ØV	NS	ØV	NS	ØV
1	5 9	6 11 4 Ruter	V 12	170	7,0	-7,0
4	4 12 15 16	WO			0,0	0,0
3	7 10	1 3 5 Ruter	Ø 13	440	0,0	0,0
2	14 13	2 8 6 NT	Ø 13	1020	-11,0	11,0

Mappen: 9(9)
Runden: 5

Nord / Ø/V

A4
Q765
932
KQ97

K83
984
AJ764
53

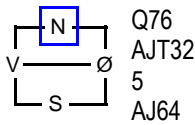

JT952
K
KQT8
T82

Bord	NS	ØV	NS	ØV	NS	ØV
2	1 14	3 9 4 Spar D	S 8	300	4,0	-4,0
1	6 10	7 12 4 Hjerter	Ø 10	620	-4,0	4,0
3	8 11	2 4 4 Hjerter	Ø 11	650	-5,0	5,0
4	5 13 15 16	WO				

Mappen: 10(10)
Runden: 5

Øst / Alle

KQJT532
A
J84
QJ

A6
K973
Q2
KT752

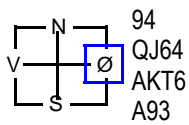

87
T852
9753
864

Bord	NS	ØV	NS	ØV	NS	ØV
4	5 13 15 16	WO			12,0	-12,0
3	8 11	2 4 4 Spar	Ø 12	680	0,0	0,0
2	1 14	3 9 4 Spar	Ø 12	680	0,0	0,0
1	6 10	7 12 4 Spar	V 12	680	0,0	0,0

Mappen: 11(11)
Runden: 6

Syd / Ingen

K83
A7543
852
K5

AT42
6
AKT963
J3

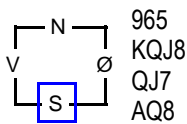

QJ7
T92
4
T97642

Bord	NS	ØV	NS	ØV	NS	ØV
2	2 1	4 10 4 Spar D	N 10	590	11,0	-11,0
1	7 11	8 13 3 Hjerter	V 7	100	2,0	-2,0
3	9 12	3 5 2 Hjerter	Ø 8	110	-4,0	4,0
4	6 14 15 16	WO				

Mappen: 12(12)
Runden: 6

Vest / N/S

762
AK982
T9
J75

93
T63
AK8752
AT

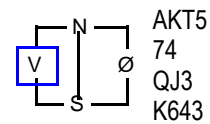

QJ84
QJ5
64
Q982

Bord	NS	ØV	NS	ØV	NS	ØV
1	7 11	8 13 2 Hjerter	Ø 6	100	4,0	-4,0
4	6 14 15 16	WO			2,0	-2,0
3	9 12	3 5 2 Spar	Ø 8	110	-2,0	2,0
2	2 1	4 10 3 NT D	S 7	500	-10,0	10,0

SPILLSTENSILER

singelen 2, 16. august 2010

Mappnr: **13(13)**
Runden: 7

Nord / Alle

QJ7
K742
A86
K63

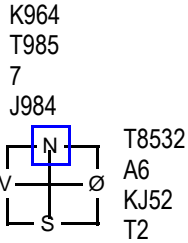

A
QJ3
QT943
AQ75

Bord	NS	ØV	NS	ØV	NS	ØV
2	3 2	5 11	2 Hjerter	N 7	100	0,0 0,0
1	8 12	9 14	3 Kløver	S 8	100	0,0 0,0
3	10 13	4 6	3 Hjerter	N 7	200	-3,0 3,0
4	7 1	15 16	WO			

Mappnr: **14(14)**
Runden: 7

Øst / Ingen

Q86
J8
Q732
AQ32

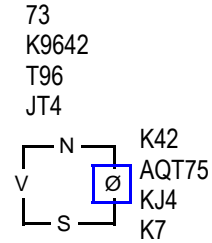

AJT95
3
A85
9865

Bord	NS	ØV	NS	ØV	NS	ØV
4	7 1	15 16	WO			
2	3 2	5 11	3 NT	V 10	430	1,0 -1,0
3	10 13	4 6	3 NT	Ø 11	460	-1,0 1,0
1	8 12	9 14	3 NT	Ø 11	460	-1,0 1,0

Mappnr: **15(15)**
Runden: 8

Syd / N/S

K
6432
AT
KT8732

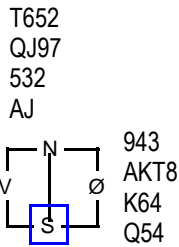

AQJ87
5
QJ987
96

Bord	NS	ØV	NS	ØV	NS	ØV
3	11 14	5 7	3 Spar	S 8	100	1,0 -1,0
2	4 3	6 12	4 Kløver	Ø 10	130	-1,0 1,0
1	9 13	10 1	4 Spar	S 7	300	-5,0 5,0
4	8 2	15 16	WO			

Mappnr: **16(16)**
Runden: 8

Vest / Ø/V

A73
AT53
86
K963

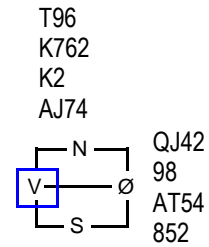

K85
QJ4
QJ973
QT

Bord	NS	ØV	NS	ØV	NS	ØV
3	11 14	5 7	1 NT	S 7	90	2,0 -2,0
2	4 3	6 12	1 NT	S 8	120	2,0 -2,0
1	9 13	10 1	Pass			-2,0 2,0
4	8 2	15 16	WO			-2,0 2,0

Mappnr: **17(17)**
Runden: 9

Nord / Ingen

A862
K954
Q
9853

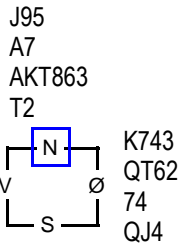

QT
J83
J952
AK76

Bord	NS	ØV	NS	ØV	NS	ØV
3	12 1	6 8	3 NT	S 11	460	8,0 -8,0
2	5 4	7 13	3 Ruter	N 10	130	0,0 0,0
1	10 14	11 2	3 Ruter	N 10	130	0,0 0,0
4	9 3	15 16	WO			

Mappnr: **18(18)**
Runden: 9

Øst / N/S

8532
J53
J76
J83

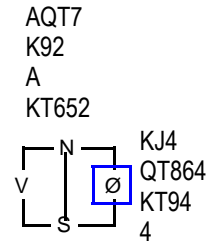

96
A7
Q8532
AQ97

Bord	NS	ØV	NS	ØV	NS	ØV
2	5 4	7 13	6 Kløver	S 12	1370	14,0 -14,0
3	12 1	6 8	3 NT	S 9	600	7,0 -7,0
4	9 3	15 16	WO			-7,0 7,0
1	10 14	11 2	6 Kløver	S 11	100	-9,0 9,0

SPILLSTENSILER

singelen 2, 16. august 2010

Mappen: **19(19)**
Runden: **10**
Syd / ØV

Q94
3
T876
QT865

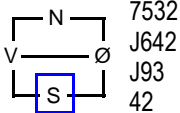

AK6
KT85
AQ542
K

Bord	NS	ØV	NS	ØV	NS	ØV
3	13	2	7	9	6	Hjertes S 13 1010 13,0 -13,0
2	6	5	8	14	4	Hjertes S 12 480 6,0 -6,0
4	10	4	15	16		WO -6,0 6,0
1	11	1	12	3	7	Hjertes N 12 50 -7,0 7,0

Mappen: **20(20)**
Runden: **10**
Vest / Alle

Q9
T43
Q72
Q8732

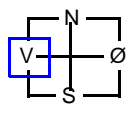

AKJ96
AT4

AJT32
AJ75
43
KJ

8764
Q62
T85
965

Bord	NS	ØV	NS	ØV	NS	ØV
2	6	5	8	14	2	Hjertes Ø 6 200 6,0 -6,0
3	13	2	7	9	2	Spar Ø 8 110 -2,0 2,0
1	11	1	12	3	3	Ruter N 7 200 -4,0 4,0
4	10	4	15	16		WO

Mappen: **21(21)**
Runden: **11**
Nord / N/S

972
4
A5
T987543

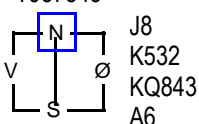

AKQ5
AJT976
J6
J

T643
Q8
T972
KQ2

Bord	NS	ØV	NS	ØV	NS	ØV
3	14	3	8	10	6	Hjertes V 12 980 0,0 0,0
2	7	6	9	1	6	Hjertes V 12 980 0,0 0,0
1	12	2	13	4	6	Hjertes V 12 980 0,0 0,0
4	11	5	15	16		WO

Mappen: **22(22)**
Runden: **11**
Øst / ØV

Q653
9853
T3
K43

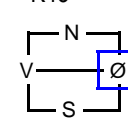

AJT
QT6
AKQ85
87

K87
AK7
J762
QJ9

Bord	NS	ØV	NS	ØV	NS	ØV
4	11	5	15	16		WO 3,0 -3,0
2	7	6	9	1	1	NT V 7 90 0,0 0,0
3	14	3	8	10	2	Ruter V 8 90 0,0 0,0
1	12	2	13	4	2	Ruter V 8 90 0,0 0,0

Mappen: **23(23)**
Runden: **12**
Syd / Alle

7542
KJ5
2
AKQ96

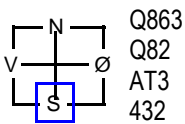

AK9
T943
QJ9864

JT
A76
K75
JT875

Bord	NS	ØV	NS	ØV	NS	ØV
1	13	3	14	5	3	Hjertes V 8 100 2,0 -2,0
3	1	4	9	11	4	Kløver S 10 130 2,0 -2,0
4	12	6	15	16		WO -2,0 2,0
2	8	7	10	2	4	Kløver N 9 100 -4,0 4,0

Mappen: **24(24)**
Runden: **12**
Vest / Ingen

KQ3
AT7542
JT6
3

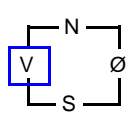

854
J8
K982
AQT4

JT92
Q9
A74
J652

A76
K63
Q53
K987

Bord	NS	ØV	NS	ØV	NS	ØV
3	1	4	9	11	2	Hjertes N 9 140 1,0 -1,0
2	8	7	10	2	2	Hjertes N 9 140 1,0 -1,0
1	13	3	14	5	2	Hjertes N 8 110 -1,0 1,0
4	12	6	15	16		WO

SPILLSTENSILER

singelen 2, 16. august 2010

Mappen: **25(25)**
Runden: **13**

Nord / ØV

A96543
AJ
Q8
QT3

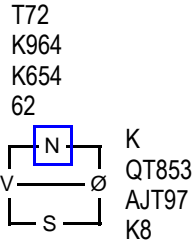

QJ8
72
32
AJ9754

Bord	NS	ØV		NS	ØV	NS	ØV
3	2	5	10 12	4 Spar	Ø 9	100	9,0 -9,0
1	14	4	1 6	4 Hjerter	Ø 10	620	-7,0 7,0
2	9	8	11 3	4 Hjerter	Ø 11	650	-8,0 8,0
4	13	7	15 16	WO			

Mappen: **26(26)**
Runden: **13**

Øst / Alle

J87652
KQ863
5
J

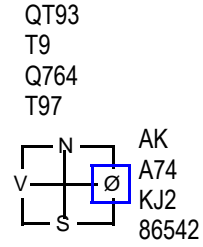

4
J52
AT983
AKQ3

Bord	NS	ØV		NS	ØV	NS	ØV
3	2	5	10 12	4 Hjerter	V 8	200	6,0 -6,0
4	13	7	15 16	WO			2,0 -2,0
2	9	8	11 3	2 Hjerter	V 8	110	-2,0 2,0
1	14	4	1 6	4 Hjerter	V 10	620	-11,0 11,0

Mappen: **27(27)**
Runden: **14**

Syd / Ingen

AQ83
A2
QJ93
JT5

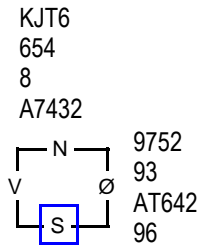

4
KQJT87
K75
KQ8

Bord	NS	ØV		NS	ØV	NS	ØV
3	3	6	11 13	5 Hjerter D	S 11	650	6,0 -6,0
2	10	9	12 4	4 Hjerter	S 10	420	0,0 0,0
1	1	5	2 7	4 Hjerter	S 10	420	0,0 0,0
4	14	8	15 16	WO			

Mappen: **28(28)**
Runden: **14**

Vest / N/S

T7
Q43
AJ9
Q7542

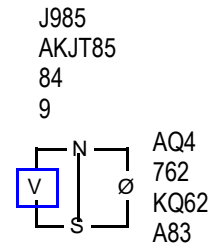

K632
9
T753
KJT6

Bord	NS	ØV		NS	ØV	NS	ØV
2	10	9	12 4	3 NT	Ø 8	50	1,0 -1,0
1	1	5	2 7	3 NT	Ø 8	50	1,0 -1,0
3	3	6	11 13	3 Kløver	V 9	110	-4,0 4,0
4	14	8	15 16	WO			